

TACT SWITCH DTSJW-6 SERIES

6x6 J SMT
Washable Type

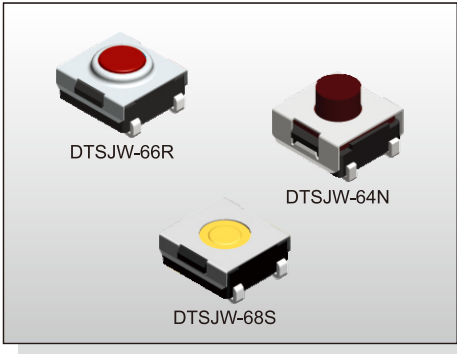

FEATURES

- ※Sealed
- ※Reflow solderable
- ※Dust proof with high reliability

APPLICATION

- ※Audio, OA equipment
- ※Instrumentation, Communication
- ※White goods

SPECIFICATION

Contact Rating	50mA, 12V DC
Contact Resistance	100mΩ max.
Insulation Resistance	100MΩ min. 500V DC
Dielectric Strength	250V AC/1 minute
Operating Force	160±50gf, Brown(N) 66/677 160±50gf, Silver(S) 68 180±50gf, Brown(N) 69/67/65/64 260±70gf, Red(R) 69/67/66/65/64 360±90gf, Transparent(T) 69/67/65/677
Travel	0.25mm 68S/66N/66R/677 0.45mm (69/67N,R)/(65/64N,R,T) 0.6mm 69/67T
Operating Life	100,000 cycles min. for 68/66/677 500,000 cycles min. for 69/67/65/64
Operating Temp.	-25°C ~ +70°C
Storage Temp.	-30°C ~ +80°C

HOW TO ORDER

D T S J W - 6

J Bend
Washable

Dimension H:
4=4.50mm (N, R)
5=3.50mm (N, R, T)
6=3.10mm (N, R)
7=5.20mm (N, R, T)
77=7.30mm (N, T)
8=2.30mm (S)
9=3.80mm (N, R, T)

Package:
B=Tube
T/R=Tape & Reel

V=RoHS & Lead Free Solderable
Q=Halogen Free

Operating Force:
N=Brown, 160gf(66N, 677N)
180gf(69N, 67N, 65N, 64N)
S=Silver, 160gf(68S)
R=Red, 260gf(69R, 67R, 66R, 65R, 64R)
T=Transparent, 360gf (69T, 67T, 65T, 677T)

CIRCUIT

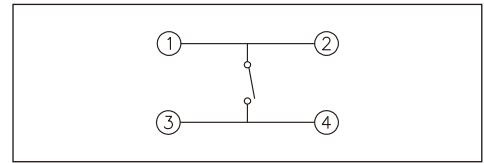

PACKAGE

<Tube>

75 pcs

<Tape & Reel>

DTSJW-64, 67: 900 pcs
DTSJW-65, 69: 1800 pcs
DTSJW-66: 1900 pcs
DTSJW-68: 2000 pcs
DTSJW-677: 650 pcs

DTSJW-66

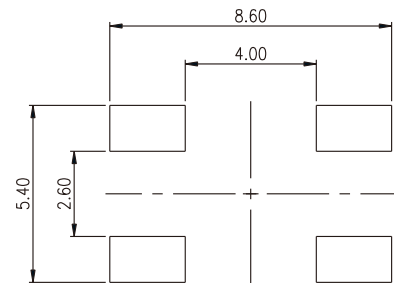
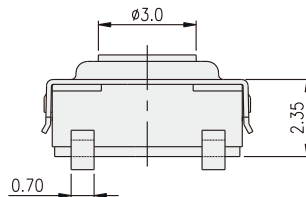
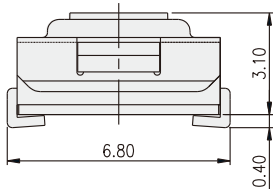
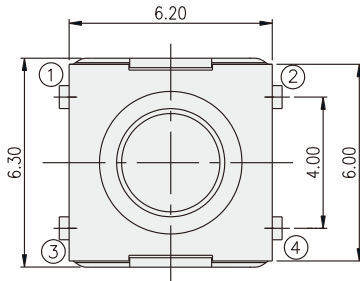

P.C.B. LAYOUT

TACT SWITCH

TACT SWITCH
DTSJW-6 SERIES

6x6 J SMT
 Washable Type



DTSJW-68

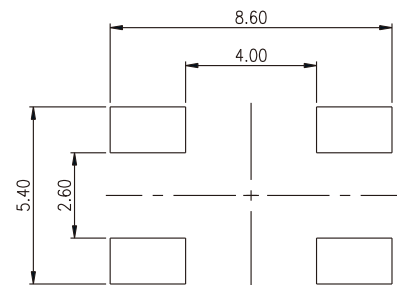
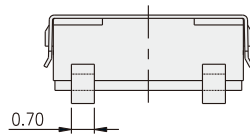
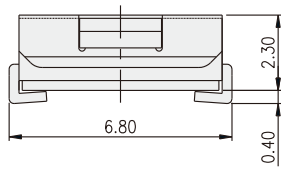
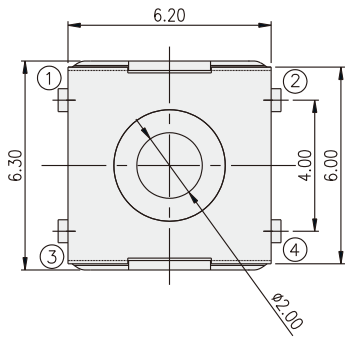

P.C.B. LAYOUT

TACT SWITCH

DTSJW-6□

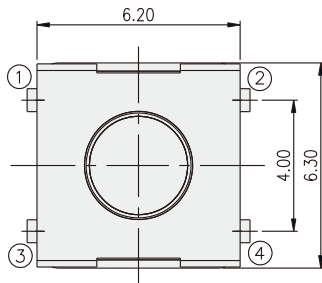

PART NO.	H
DTSJW-64	4.50
DTSJW-65	3.50
DTSJW-67	5.20
DTSJW-69	3.80
DTSJW-677	7.30

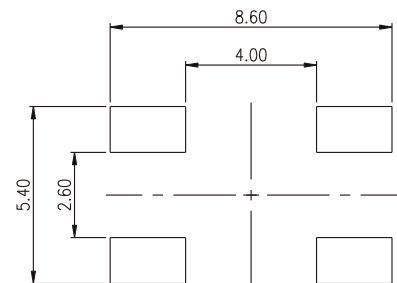
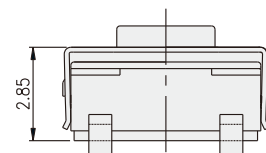
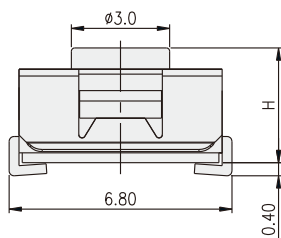

P.C.B. LAYOUT