

# ILLUMINATED SWITCH ZKS SERIES

## Key Switches Illuminated

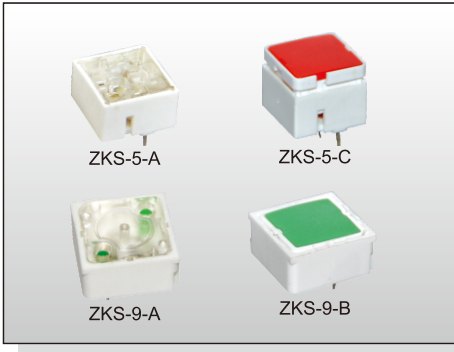

ILLUMINATED SWITCH



### FEATURES

- ✘ Several color caps are available
- ✘ High reliability contact · clear switching feedback
- ✘ High brightness LED. Button surface are illuminated and even

### APPLICATION

- ✘ Medical equipment (Medical Bed)
- ✘ Lighting
- ✘ Instrument panel
- ✘ Operating machine panel
- ✘ Audio control panel, NC panel

### SPECIFICATION

Contact Rating	100mA max, 42V AC/DC
Contact Resistance	100mΩ max. Initial
Insulation Resistance	1000MΩ min.
Dielectric Strength	1,000V AC
Operating Force	3±0.75N
Travel	0.6mm
Operating Life	1,000, 000 cycles
Operating Temp.	-25°C ~ +75°C

### HOW TO ORDER

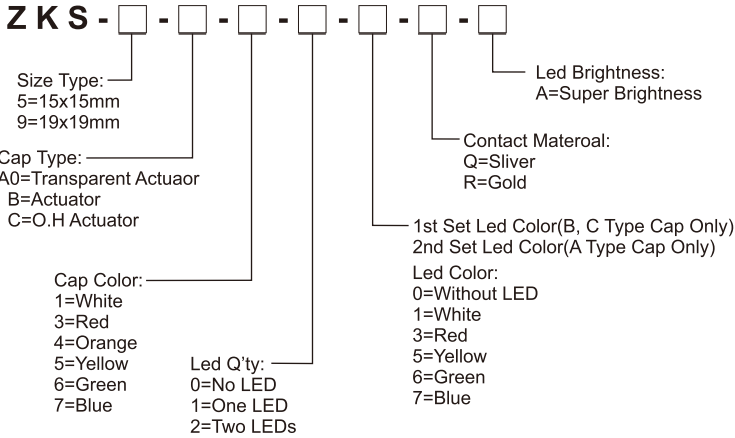

### CIRCUIT

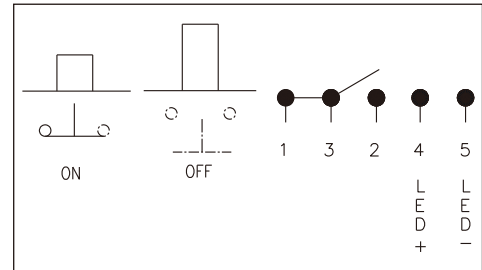

### PACKAGE

<Tray>  
135 pcs.

### WITH LED ELECTRO-OPTICAL DATA

#### ■ 1st Set LED Color

Lens Appearance	Color	Electro-optical Data(AT 20mA)				Peak Wavelength	Viewing Angle 2θ 1/2(deg)
		Vf(V)		Iv(mcd)			
		Typ.	Max.	Typ.	Min.		
Water Clear	White	3.2	3.7	270	160	635	150°
	Red	2	2.5	95	50		
	Yellow	2	2.5	150	80		
	Green	2	2.5	45	25		
	Blue	3.1	3.6	50	20		

#### ■ 2nd Set LED Color

Lens Appearance	Color	Electro-optical Data(AT 20mA)				Peak Wavelength	Viewing Angle 2θ 1/2(deg)
		Vf(V)		Iv(mcd)			
		Typ.	Max.	Typ.	Min.		
Water Diffused	Cool White	3.3	4	3300	2200	630	45°
Red Diffused	Super Bright Red	2.05	2.6	850	460	630	45°
Yellow Diffused	Super Bright Yellow	2	2.6	500	220	590	40°
Green Diffused	Green	2	2.6	150	63	575	40°
Blue Diffused	Super Bright Blue	3.5	3.8	1300	690	468	45°

### ZKS5A

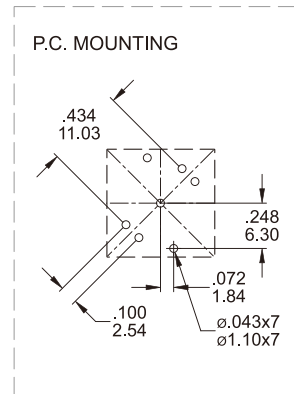
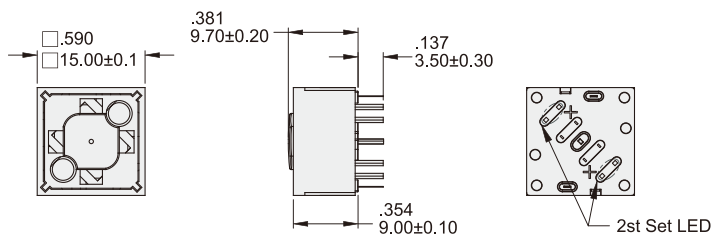

**ZKS5B**

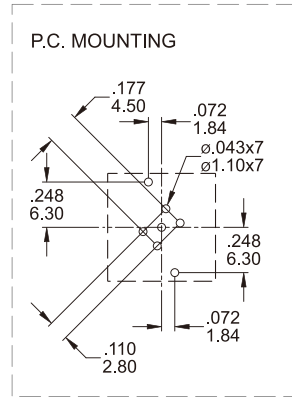
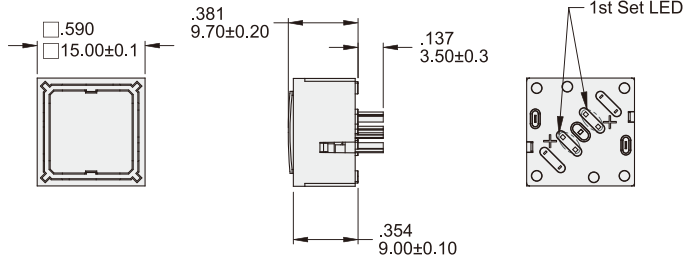

**ZKS5C**

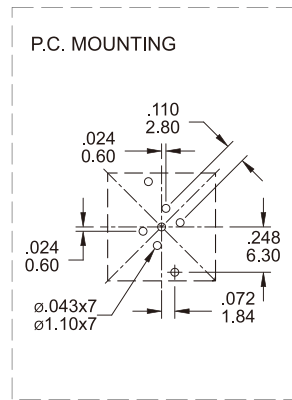
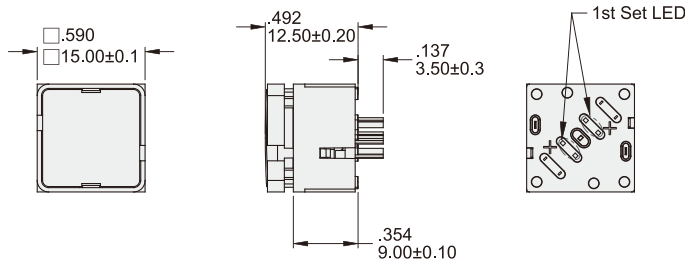

**ZKS9A**

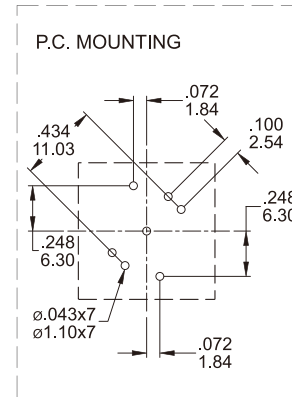
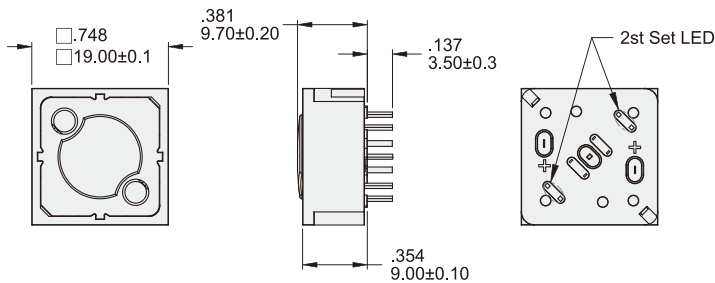

**ZKS9B**

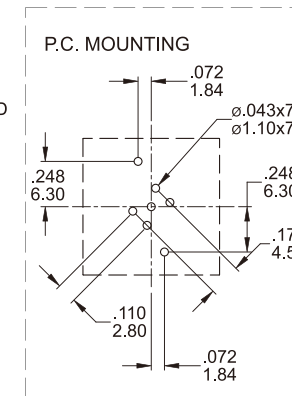
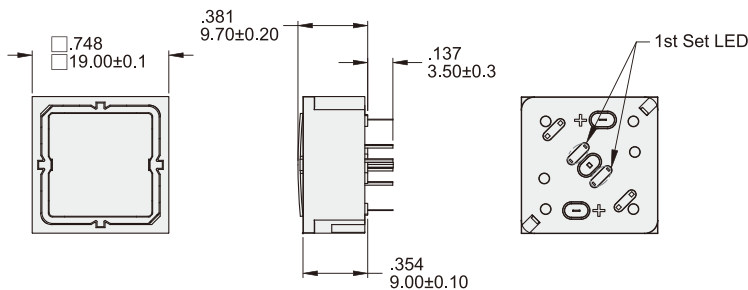

ILLUMINATED SWITCH