

**FEATURES**

- ※ 1P3T model
- ※ Single-side recoil type
- ※ Reflow solderable

**APPLICATION**

- ※ Remote control
- ※ Consumer electronics
- ※ Instrumentations

**SPECIFICATION**

Contact Rating	0.3A, 4V DC
Contact Resistance	100mΩ max.
Insulation Resistance	100MΩ min. 500V DC
Dielectric Strength	500V AC/1 minute
Operating Force	320±150gf (ON-TEST) 320±150gf (OFF-ON) 500+100/-200gf (ON-OFF)
Travel	2mm (ON-TEST) 4mm (OFF-ON) 4mm (ON-OFF)
Operating Life	10, 000 cycles
Operating Temp.	-20°C ~ +70°C
Storage Temp.	-40°C ~ +85°C

**HOW TO ORDER**

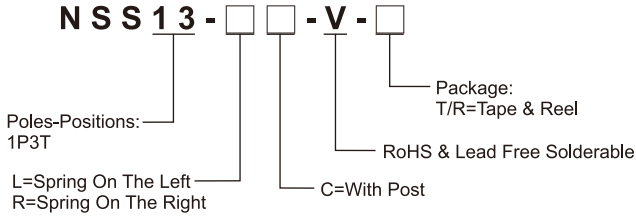

**CIRCUIT**

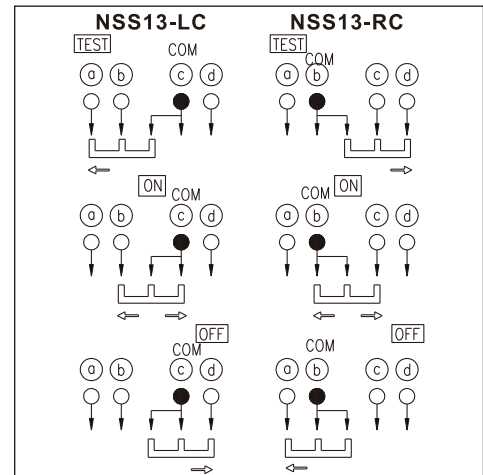

**PACKAGE**

<Tape & Reel>  
800 pcs

**NSS13-LC**

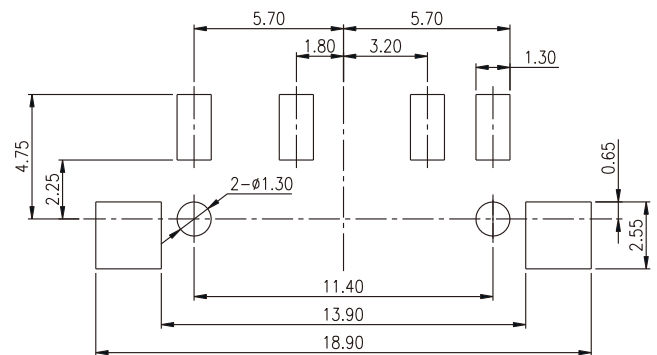
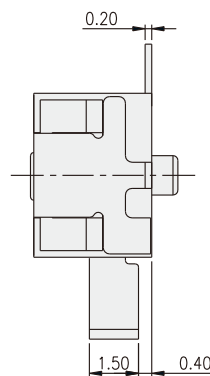
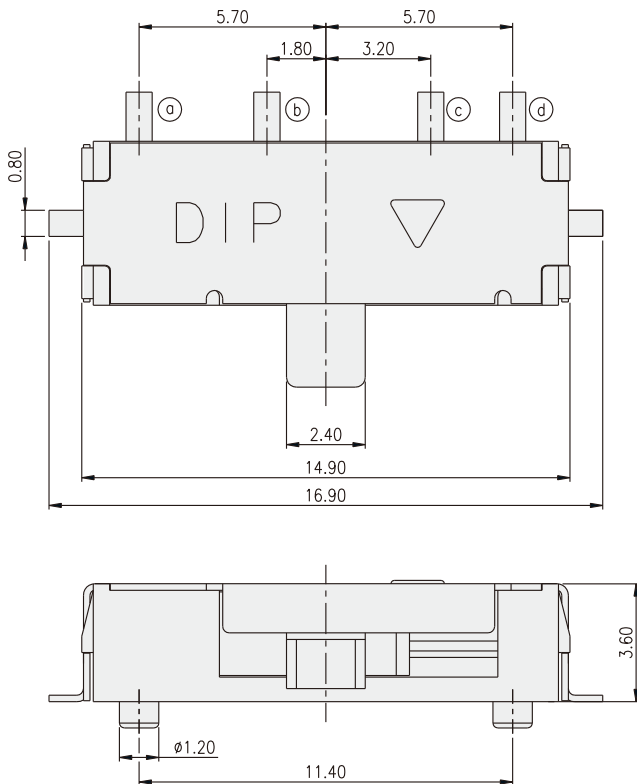

P.C.B. LAYOUT

NSS13-RC

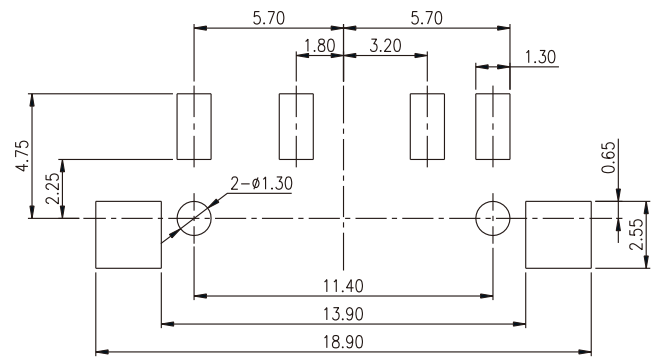
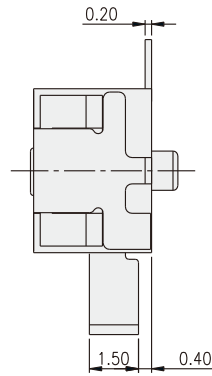
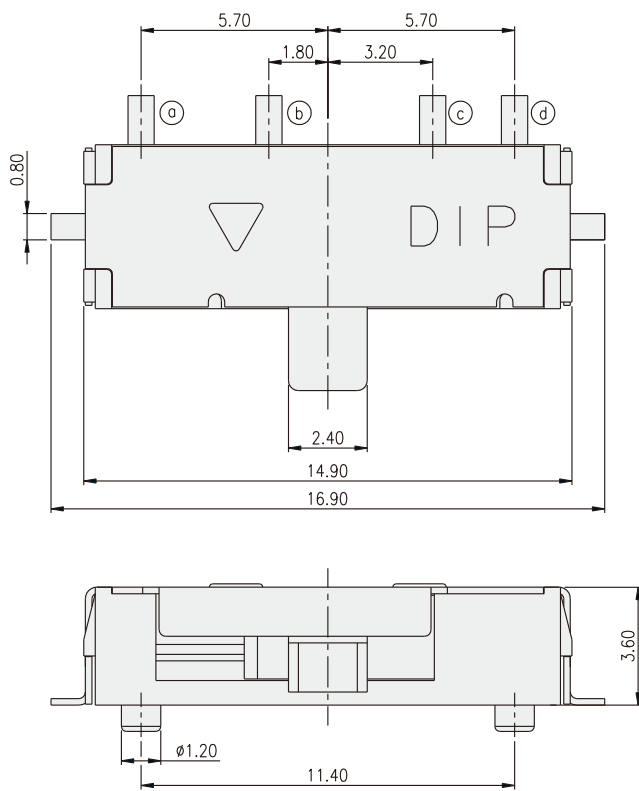

P.C.B. LAYOUT